

STRUTTURE IN C.A.P.

— STRUTTURE PLURIPIANO —

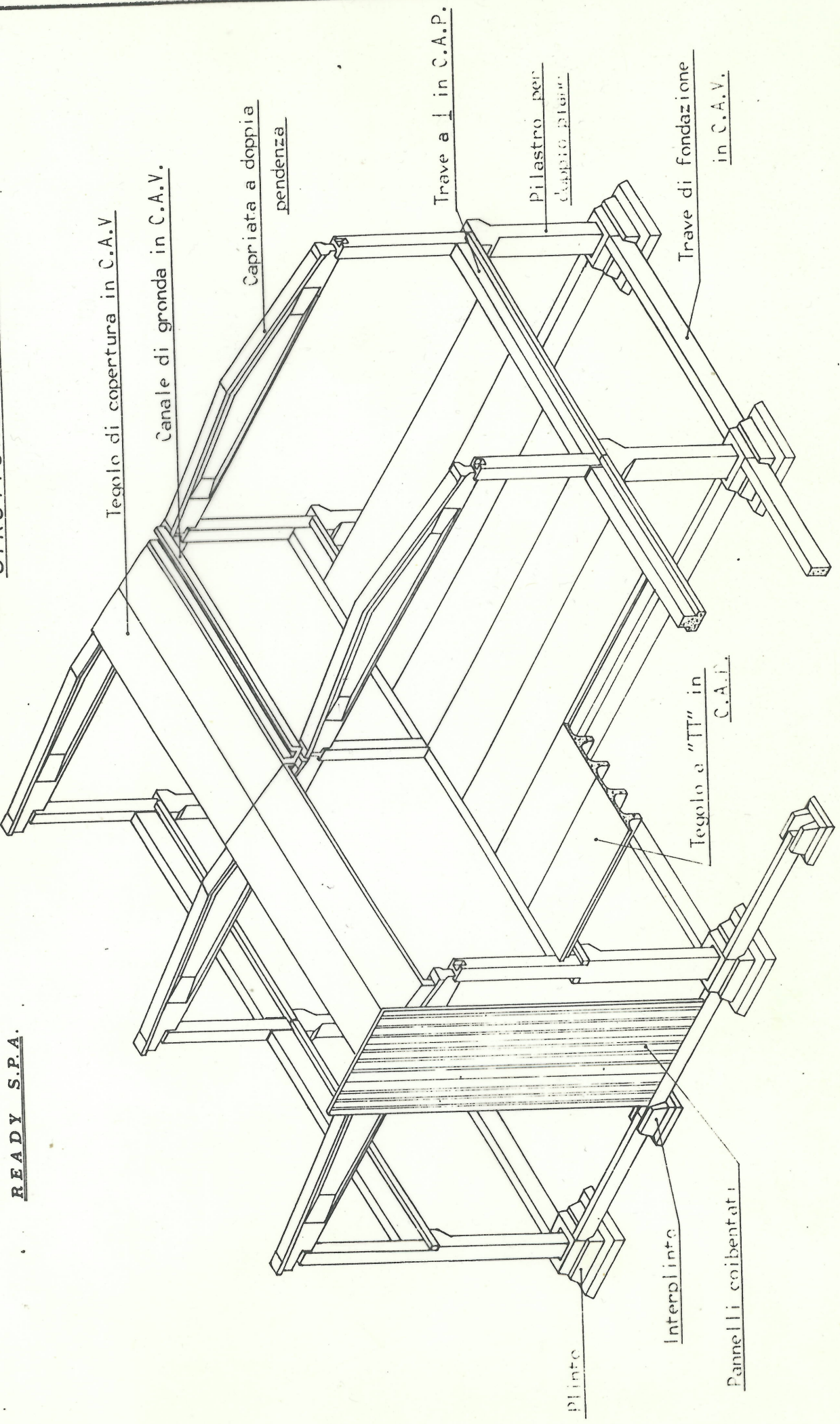

READY S.P.A.

**SEZIONI
PIANO UNICO**

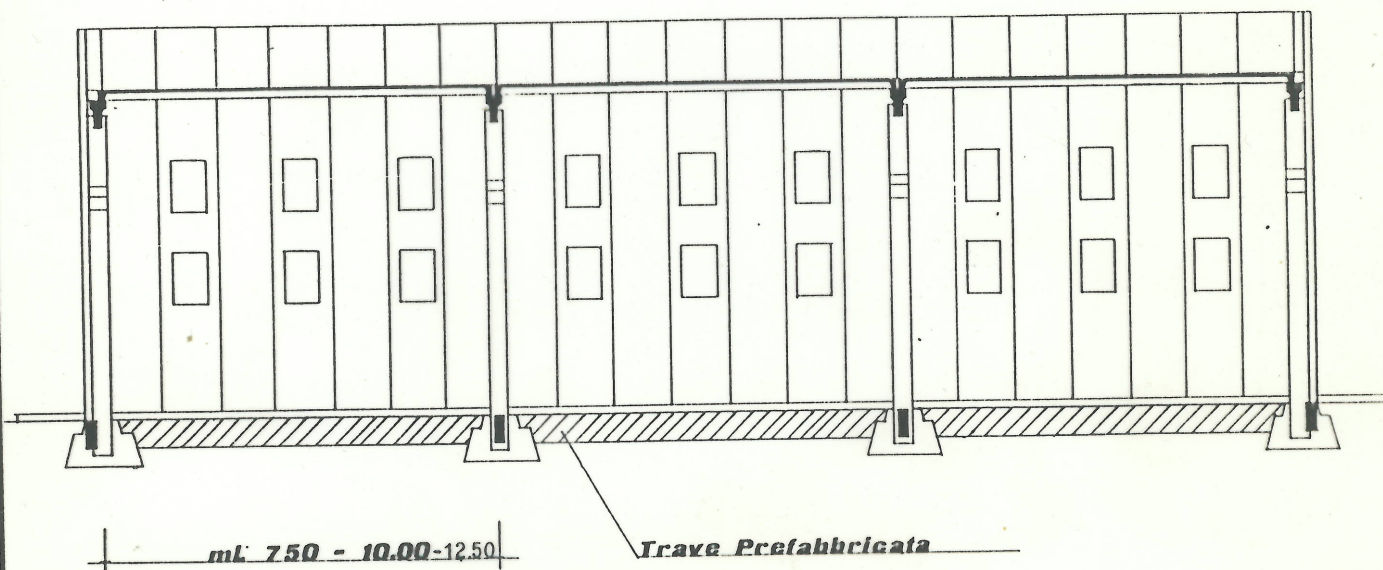
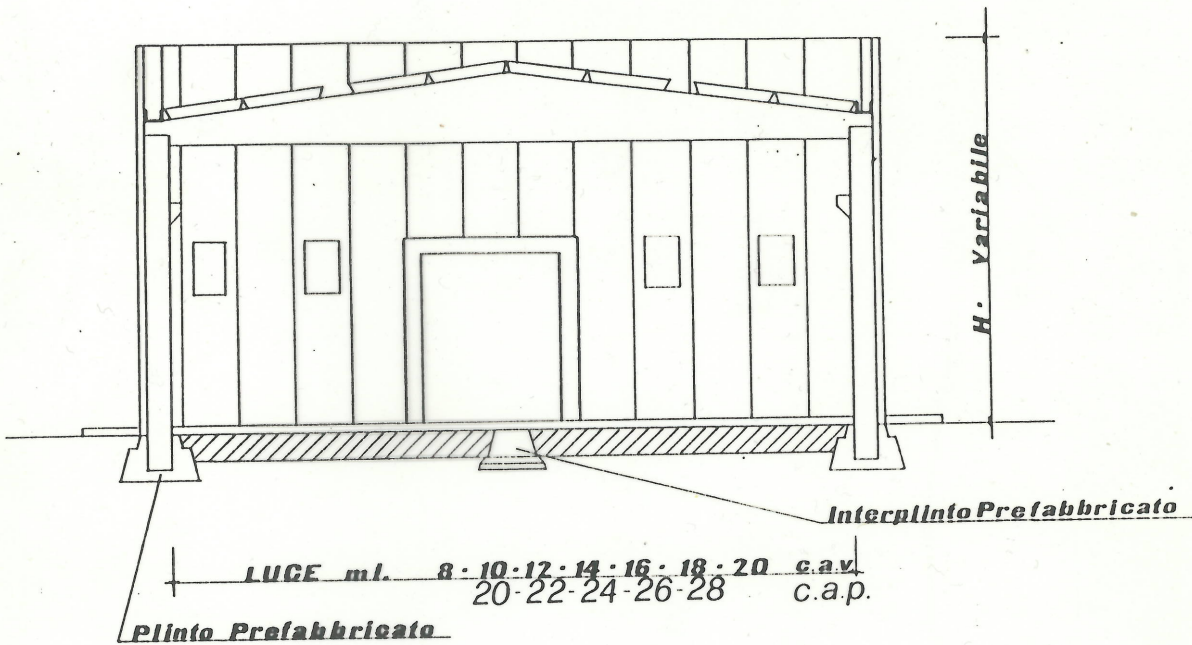

— CAPRIATA IN C.A.V. —

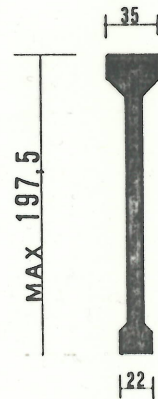
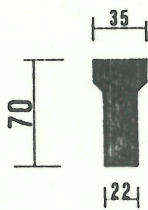
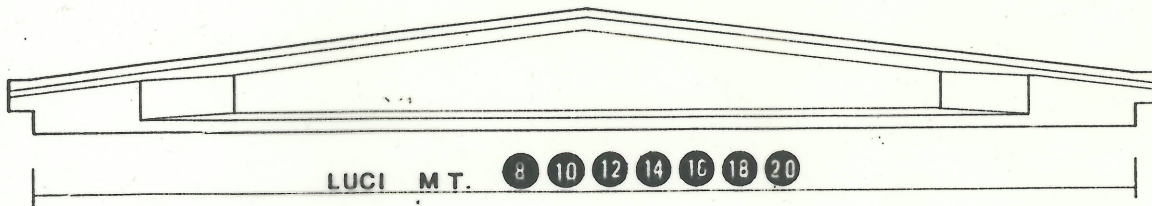

— CAPRIATA IN C.A.P. —

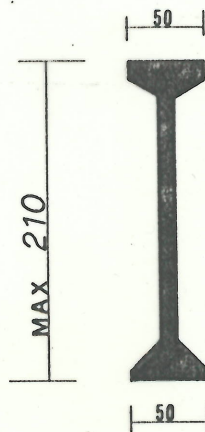
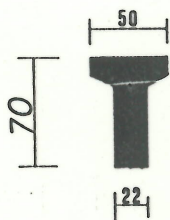
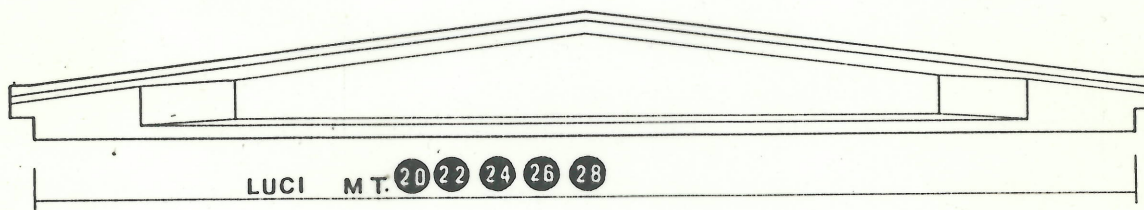

TRAVE DI FONDAZIONE

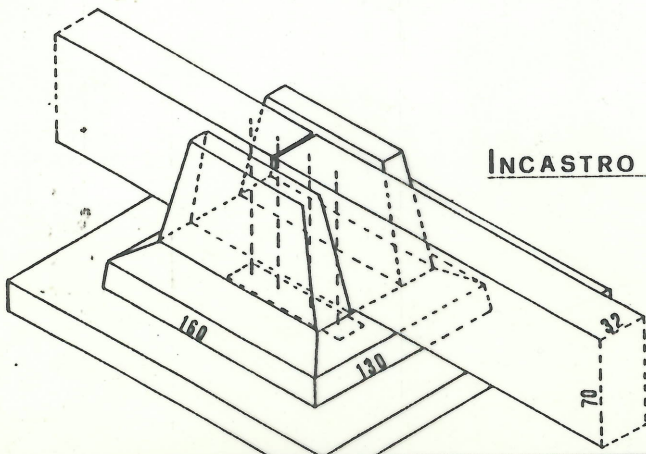
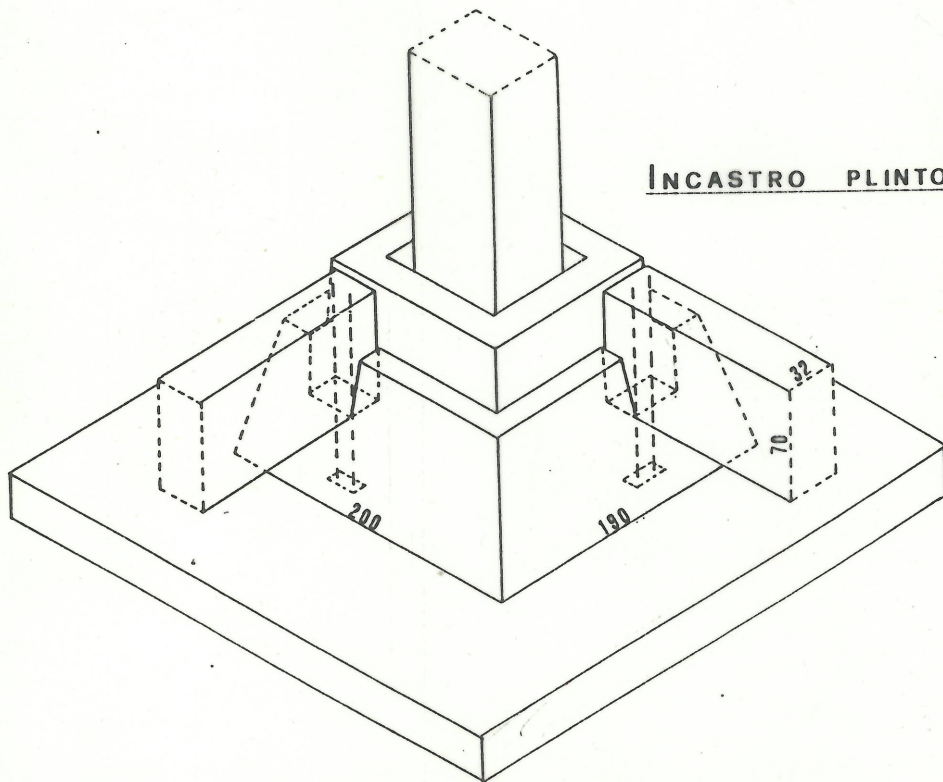
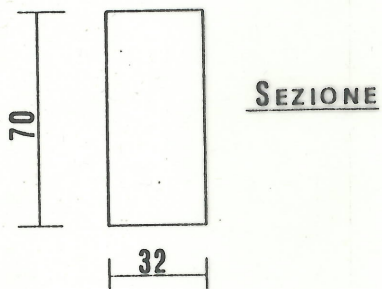
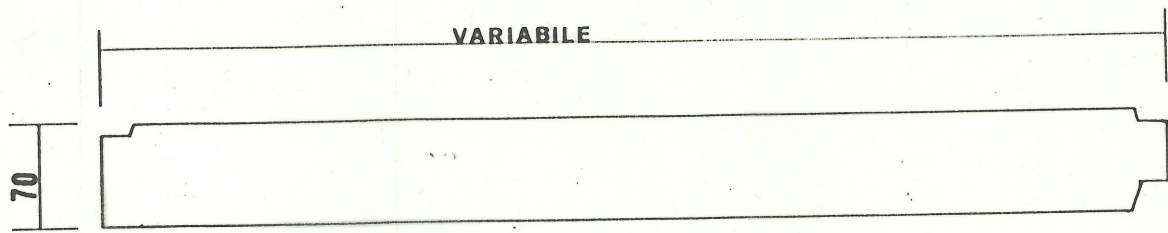

SISTEMA DI IMPERMEABILIZZAZIONE (READY S.P.A.)

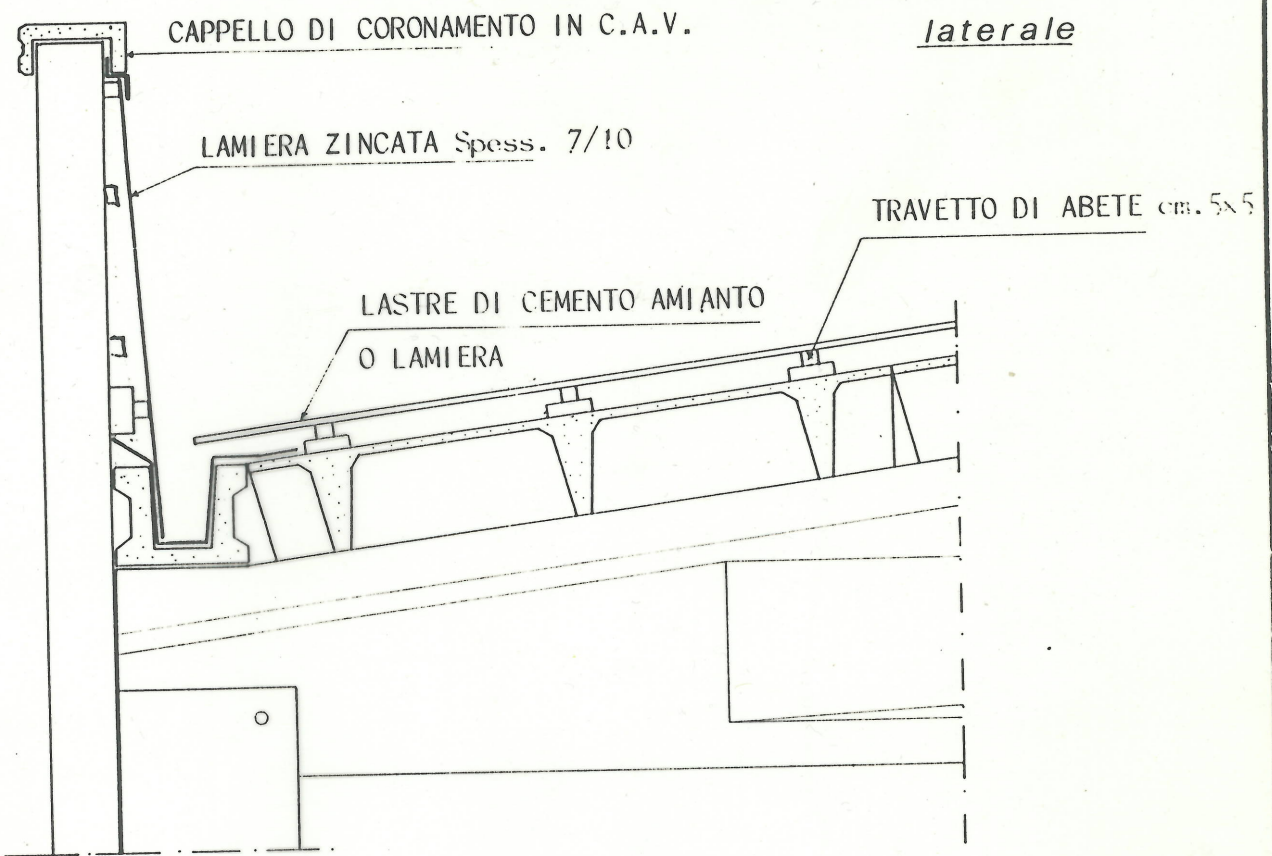

centrale

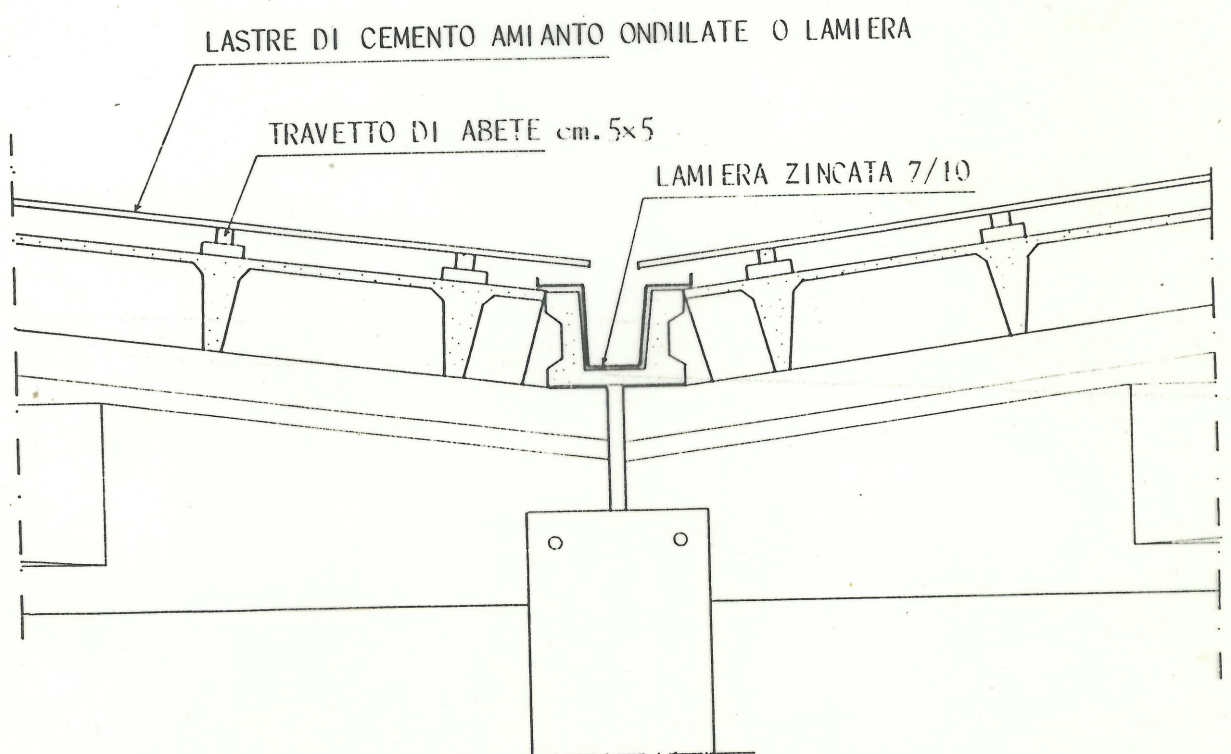

CANALE DI GRONDA [in c.a.v.p.]

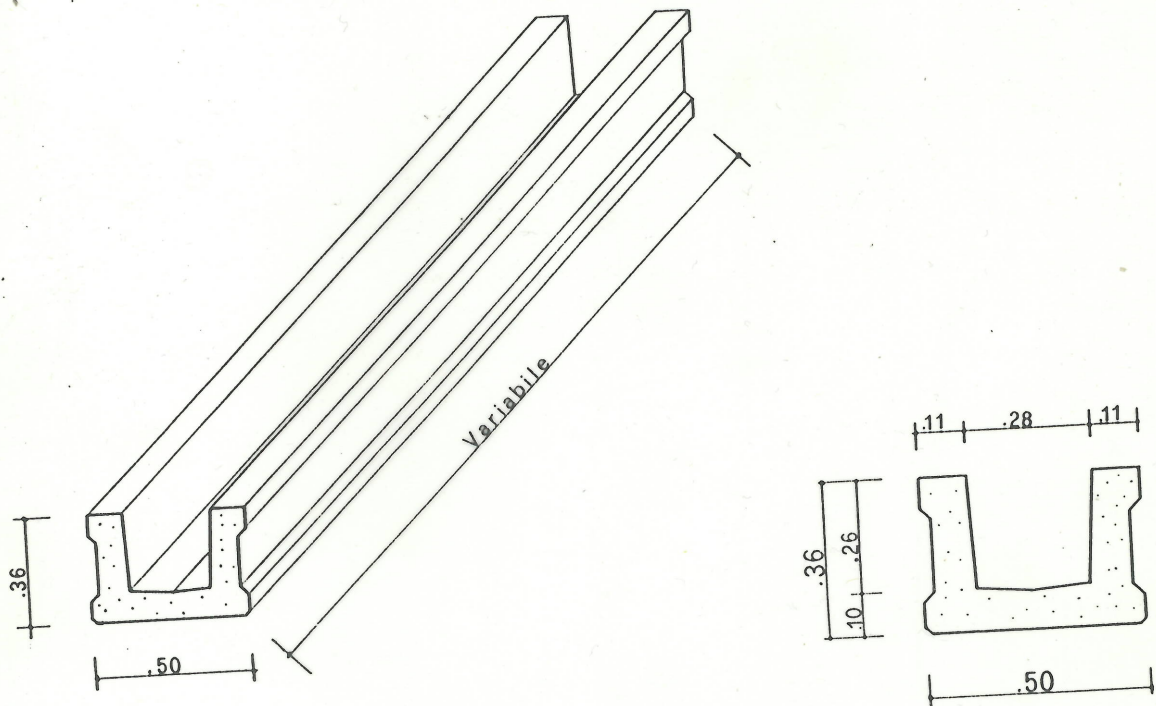

ELEMENTO DI COPERTURA [in c.a.v.p.]

